

**DESIGN LOADS**  
 PER 2016 CRC AND PER 2016 CBC, WHERE CRC SECTION 301.1.3 APPLIES.  
 ROOF LIVE LOAD: 30 psf  
 MAX SNOW LOAD: 120 psf\*  
 FLOOR LIVE LOAD: 50 psf  
 M.H. UNIT WEIGHT:  
 50 psf max, 22 psf min.  
**SEISMIC DESIGN CRITERIA:**  
 ANY LOCATION IN CA OK, EXCEPT SITE CLASS "F" REQUIR'G GEOTECH REVIEW.  
 $S_s=2.22$ ,  $S_dS=1.48$  MAX\*  
 $F_a=1.0$  at  $S_s > 1.25$   
**WIND DESIGN CRITERIA:**  
 110 to 140 mph Exp C\*  
 FOR SEISMIC  $S_s > 2.22$  OR \*WIND Exp D, CONTACT US  
 † FOR SNOW LOADS OVER 100 psf, FOOTING MUST BE WIDENED TO 15", AND THE CLEARANCE FROM PANEL BTM TO BTM OF TRENCH MUST INCREASE TO 6" MIN

SINGLE-WIDE HOME FOUNDATION IS IDENTICAL EXCEPT THAT MAX DESIGN WIND SPEED IS 110 MPH.

**MULTIPLE-WIDE PLAN** N.T.S.

PANELS FOLD AROUND CORNERS (W/50% SAW KERFING) OR PANEL EDGES ARE CAULKED TOGETHER AT CORNERS.

DESIGN LOADS CAN BE MODIFIED WITH PROJECT-SPECIFIC ENGINEERING

COAT OVER THE GALVANIZED PANELS PRIOR TO BACKFILL. LEAVE NO VOIDS IN THE COAT. SEE NOTE 5 ON SHEET 2.

BACKFILL CAN BE PLACED UP TO 3' HIGH TYP. GRADES MUST FALL 6" MIN WITHIN 10' OF HOME. OK TO FILL UP TO ANY CLADDING THAT IS OK FOR SOIL CONTACT. KEEP SOIL 6" MIN CLEAR OF BLDG.

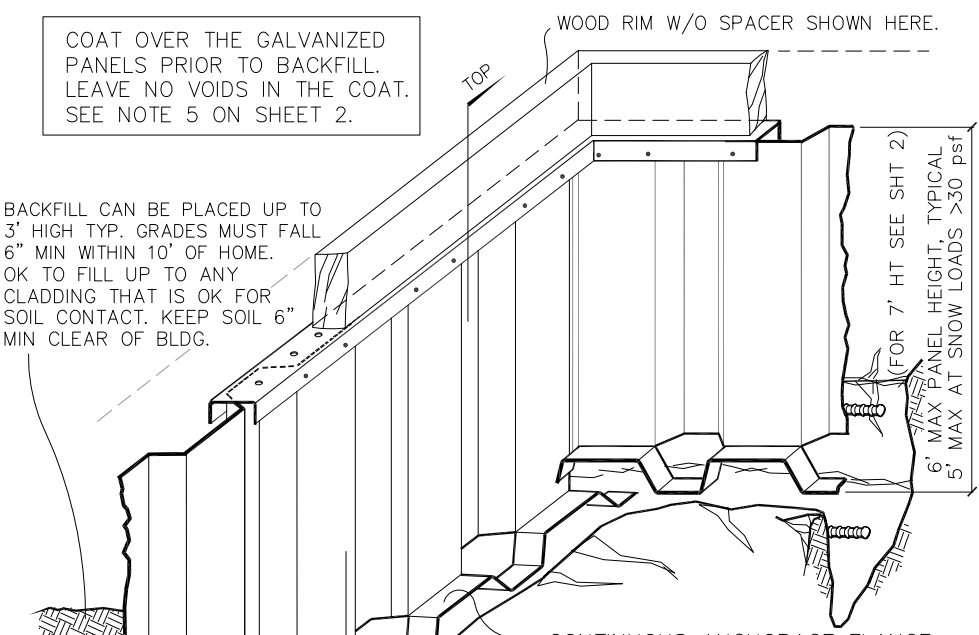

CONTINUOUS ANCHORAGE FLANGE CAN FACE TOWARD INTERIOR OR EXTERIOR CONCRETE BEING PLACED

**ANCHORPANEL PERIMETER**

VIEW FROM THE INTERIOR DURING CONCRETE PLACEMENT

1. ALL PANEL STEEL MATERIAL TO MEET ASTM A-653 18 GA (0.043") MIN, GRADE 40 MIN, G-210 GALV MIN.
2. TOP DETAIL SCREWS TO BE HD GALV OR ZINC PLT.
3. PANEL DEFORMATIONS AT BOTTOM TO MEET DETAILS.
4. IN-SITU CONCRETE 28 DAY STRENGTH TO BE 2500psi.
5. REINFORCING BARS PER ASTM A-615 GRADE 40 MIN.
6. 1-STORY FOOTING TYPICAL - SEE NOTES ON SHEET 2.

**MANUFACTURED HOME/MOBILE HOME FOUNDATION SYSTEM**  
**HEALTH AND SAFETY CODE, SECTION 18551**  
**APPROVED**

APPROVAL DOES NOT AUTHORIZE OR APPROVE ANY OMISSIONS OR DEVIATION FROM REQUIREMENTS OF APPLICABLE STATE LAWS AND REGULATIONS  
 State of California  
 Department of Housing and Community Development

DIVISION OF CODES AND STANDARDS

BY [Signature] DATE 9/25/17  
 SPA NO. 92-2F (signature)  
 This Plan Approval Expires 9/11/19

THIS DESIGN DOES NOT CONSTITUTE A SITE EVALUATION. SUITABILITY OF SITE CONDITIONS FOR THIS OR ANY FOUNDATION IS NOT IMPLIED.



FAST TRACK™ Foundation Systems  
 US PAT NOS. 6,076,320 6,205,725  
 ANCHORPANEL.COM (707) 961-1891  
 FORT BRAGG, CALIFORNIA 95437

**ANCHORPANEL® FOUNDATION SYSTEM**

© CA SPA-92-2F MODIFIED: 9/15/2017  
 THIS SHEET MAY BE REPRODUCED, IN PART OR WHOLE, ONLY FOR PURPOSES RELATING TO AN ANCHORPANEL FOUNDATION SUPPLIED BY FAST TRACK FOUNDATION SYSTEMS. OTHER USES PROHIBITED.

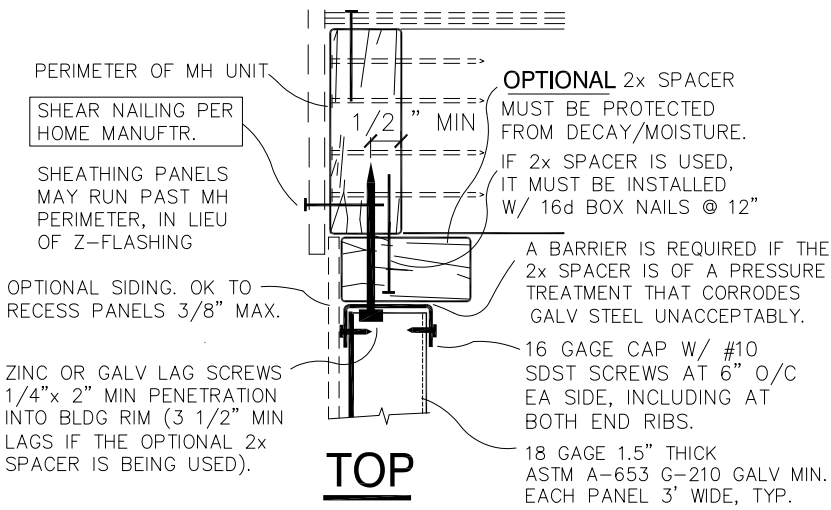

**LAG SCREW FASTENING REQUIREMENTS :**

2 LAG SCREWS PER FOOT OF PANEL (EXCEPT AT VENTS), TYPICAL.  
 LOCATIONS WITH DESIGN SNOW LOADS GREATER THAN 30 psf UP TO 120 psf REQUIRE 3 LAG SCREWS PER FOOT PF PANEL.

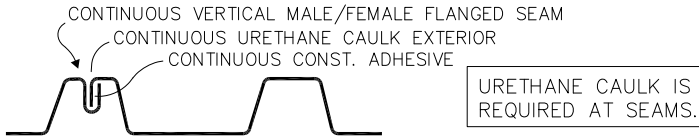

**PLAN/SECTION DETAIL @ SEAM**

SEAMS AT 3' O/C ABOUT THE PERIMETER TYPICAL

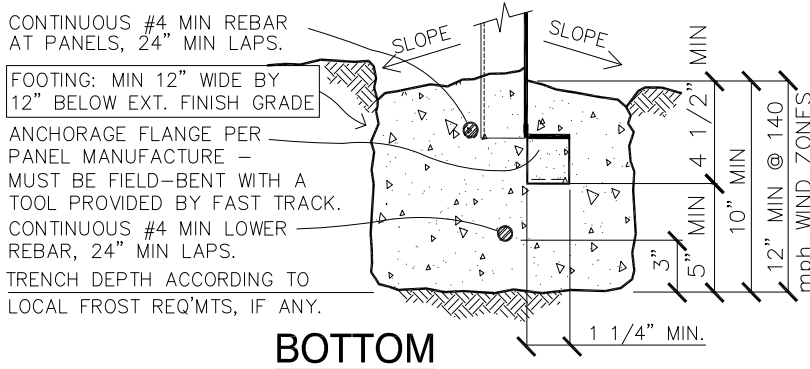

**INSTALLATION NOTES**

**INSTALLATION / SITE REQUIREMENTS**

PROPERLY INSTALLED ANCHORPANEL WILL PROVIDE LOAD-SPREADING GRADE-BEAM PROPERTIES SUPERIOR TO ANY INTERIOR PIER OR TIE-DOWN FOUNDATION SYSTEM.

- SOIL CONDITIONS SHOULD BE SUITABLE FOR CONVENTIONAL CONSTRUCTION, WITH A MINIMUM BEARING STRENGTH OF 1000psf. CLAYS WHICH ARE TOO EXPANSIVE FOR CONVENTIONAL FOUNDATION CONSTRUCTION SHALL NOT BE BUILT UPON WITHOUT A GEOTECHNICAL APPROVAL BY OTHERS.
- THIS SYSTEM IS SUITABLE FOR SLOPING SITES, PROVIDING MAXIMUM PANEL HEIGHT IS THAT SHOWN, AND FOOTING TRENCHES AT SLOPES > 10% ARE LEVEL-STEPPED. TALLER PANELS CAN BE UTILIZED ONLY WITH PROJECT-SPECIFIC CALCULATIONS BY A CALIF LICENSED ENGINEER.
- FINISH GRADES SHALL SLOPE PER CRC REQS TO DRAIN SURFACE WATER AWAY FROM FDN. EXCEPTIONS CAN BE UTILIZED WITH PROJECT-SPECIFIC PROFESSIONAL CIVIL ENGINEERING.
- INSTALLATION IN FLOOD HAZARD AREAS SHALL BE PER SHEET 2 OF 2 OF THIS SPA.
- LOW PROFILE SETS SHALL BE MADE IN CONSIDERATION OF SITE MOISTURE, AND ONLY WHERE SUCH CONDITIONS ALLOW A SUITABLY DRY CRAWL-SPACE. FOLLOW CA STATE DRAINAGE DESIGN WHERE REQUIRED.

- FOUNDATION WALL PANELS TO BE ATTACHED PER TOP & SEAM DETAIL BEFORE CONCRETE PLACEMENT.
- TOP FOOTING REBAR SHALL BE USED TO TRUE PANELS.
- CONCRETE SHALL BE PLACED BY PUMP, AND PANELS SHALL BE CHECKED FOR PLUMB (+/- 2%) BEFORE CONCRETE HAS SET. EXTERIOR CONCRETE SHALL SLOPE AWAY FROM PANELS.
- FOUNDATION PANELS MAY BE CLAD WITH CEMENTITIOUS PANELS FOR PROTECTION FROM SOIL BACKFILL, PROVIDING CEMENTITIOUS PANELS EXTEND TO AND SEAL AT FOOTING TO PREVENT INFESTATION IN AREAS OF HIGH TERMITE RISK, AND THEY ARE SUITABLE FOR SUB-GRADE ENVIRONMENTS.
- FOR ALL PANELS THAT ARE NOT CLAD PER NOTE 4, ENTIRE PANEL EXTERIOR SURFACES SHALL RECEIVE A THOROUGH COATING OF AN EMULSIFIED TAR BASED BARRIER COMPOUND ("TAR"), PRIOR TO ANY BACKFILLING OPERATION OR CONTACT WITH SOIL. INTERIOR SURFACES NEED TAR TREATMENT IF THEY WILL COME IN CONTACT WITH SOIL OR SALT-LADEN AIR. A CEMENT-COAT OF 33% MIN PORTLAND CEMENT MAY SUBSTITUTE FOR "TAR", PROVIDING ADHESION TO PANELS IS ASSURED BY PREPARATION AND POLYMER ADDITION.

- ANCHORPANEL SHALL NOT BE INSTALLED IN HIGHLY CORROSIVE LOCATIONS, SUCH AS THOSE EXPOSED TO SALT SPRAY, UNLESS ADDITIONAL MEASURES ARE TAKEN FOR CORROSION PROTECTION.
- IF INTERIOR SUPPORTS SETTLE, THEY SHALL BE ADJUSTED AS REQUIRED.
- MULTI-WIDE HOMES CAN HAVE UP TO 7' HIGH PANELS, IF ADJACENT INT PADS ARE OF SITE-CAST CONCRETE AND ARE DOWELED INTO THE PERIMETER FOOTING WITH 2-#4 BARS.

ANCHORPANEL MUST BE INSTALLED WITH CONTINUOUS PANELS AROUND ENTIRE HOME, WITH VENT-PANELS AND ACCESS OPENINGS INSTALLED PER THIS SHEET ONLY. END WALLS OF DBL-WIDE HOMES CAN HAVE ONLY 2 VENT OR DOOR OPENINGS, UNLESS FASTENED WITH 3 LAG SCREWS PER FOOT OF PANEL. END WALLS OF SINGLE-WIDE CANNOT HAVE ANY VENT OPENINGS WITHOUT APPROVAL.

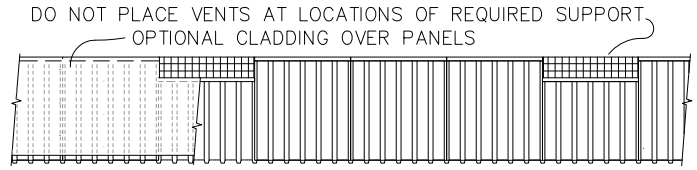

**DROPPED PANELS FOR VENTILATION:**

ANY 1 IN 4 CONTIGUOUS PANELS MAY HAVE THE TOP LOCATION LOWERED TO CREATE VENTILATION OPENINGS, TYPICAL OF ALL INSTALLATIONS EXCEPT AT THE END WALLS OF SINGLE-WIDE UNITS (WHICH CAN HAVE NO VENT OPENINGS). TYPICAL WALLS MUST HAVE MIN 2 PANELS BETWEEN ANY 2 OPENINGS. OPENINGS SHALL BE SCREENED WITH 1/4" MESH. A CRAWL-SPACE ACCESS OPENING CAN SUBSTITUTE FOR ANY VENT OPENING.

**MANUFACTURED HOME/MOBILE HOME FOUNDATION SYSTEM HEALTH AND SAFETY CODE, SECTION 18551 APPROVED**

**APPROVAL DOES NOT AUTHORIZE OR APPROVE ANY OMISSIONS OR DEVIATION FROM REQUIREMENTS OF APPLICABLE STATE LAWS AND REGULATIONS**

State of California  
 Department of Housing and Community Development

DIVISION OF CODES AND STANDARDS  
 BY *[Signature]* DATE 9/25/17  
 SPA NO. 192-2F (signature)  
 This Plan Approval Expires 9/11/19



**ANCHORPANEL® FOUNDATION SYSTEM**

**PERMANENT PERIMETER FOUNDATION FOR MANUFACTURED HOMES**

**SHEET 2 OF 3**

SHEET 3 NOT REQ'D OUTSIDE OF FLOOD ZONES

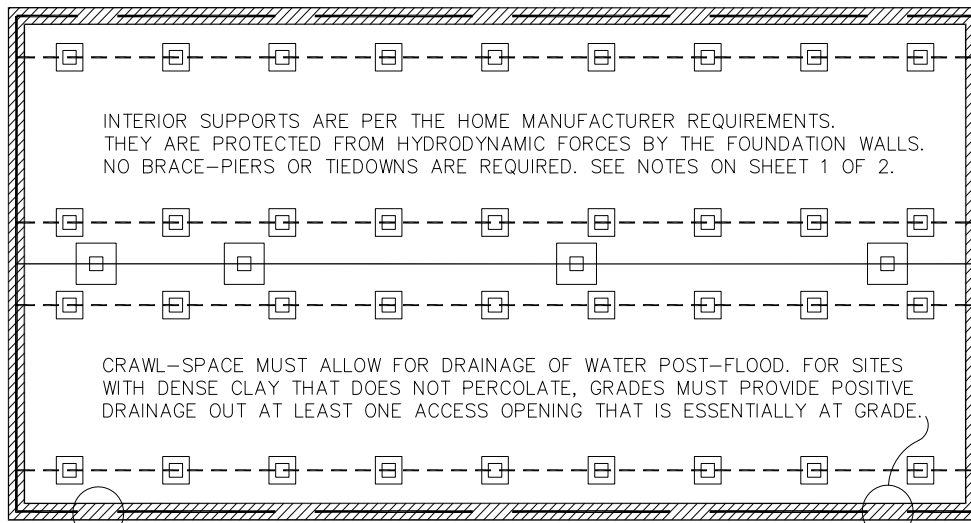

**FOUNDATION SCHEMATIC PLAN**

SEE SHEETS 1 AND 2 FOR SPECIFICS AND LIMITATIONS

ADJACENT GRADES SHALL FALL A MINIMUM OF 6' WITHIN 10', ALL DIRECTIONS FROM FOUNDATION.

FLOOD / VENT OPENINGS REQUIRED AT BOTH LONGITUDINAL WALLS, WITHIN 12" OF GRADE.

- PROVIDE AT LEAST 1 SQ. INCH OF VENT AREA FOR EACH SQ. FT OF CRAWL-SPACE AREA.
- IF NOT ALSO AIR VENTS, MUST AUTOMATICALLY OPEN TO ALLOW UNOBSTRUCTED FLOW OF WATER.
- BALANCE OPENINGS BETWEEN LONGIT. WALLS.
- TRANSVERSE WALLS SHALL NOT HAVE OPENINGS EXCEEDING 25% OF THE TOTAL WALL WIDTH.
- TRANSVERSE WALLS OF SINGLE-WIDE HOMES MAY NOT HAVE VENT OPENINGS UNLESS INSTALLED WITH NEXT-HIGHER FASTENING SCHEDULE.

OPTIONAL CLADDING OVER FOUNDATION PANELS, MUST BE APPROVED WET-FLOODPROOF MATERIALS.

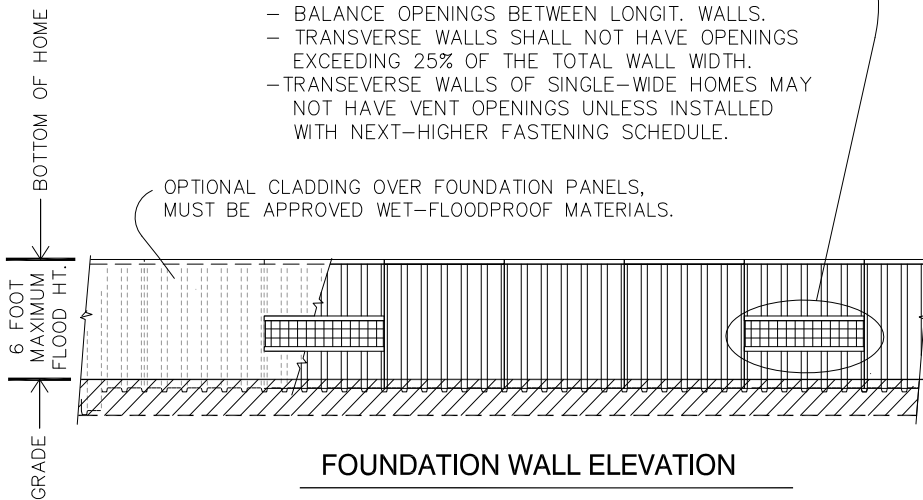

**FOUNDATION WALL ELEVATION**

SHOWING FEMA-REQUIRED FLOOD VENTS

**MANUFACTURED HOME/MOBILE HOME  
FOUNDATION SYSTEM  
HEALTH AND SAFETY CODE, SECTION 18551  
APPROVED**

**APPROVAL DOES NOT AUTHORIZE OR APPROVE ANY  
OMISSIONS OR DEVIATION FROM REQUIREMENTS OF  
APPLICABLE STATE LAWS AND REGULATIONS**  
State of California  
Department of Housing and Community Development

DIVISION OF CODES AND STANDARDS

BY [Signature] DATE 9/25/17

SPA NO. 92-2F (signature)

This Plan Approval Expires 9/11/19

**FLOOD DESIGN NOTES**

ALSO SEE NOTES ON SHEETS 1 AND 2.

THIS DISASTER MITIGATING FOUNDATION DESIGN MEETS FEMA-NFIP FLOOD MITIGATION DESIGN REQUIREMENTS AND 2016 CRC REQUIREMENTS.

THE HOME MUST BE SET ENTIRELY ABOVE THE DESIGN FLOOD ELEVATION, AS THE HOME IS NOT BUILT OF FLOOD-PROOF MATERIALS.

THIS DESIGN IS GOOD FOR ALL TYPE A FLOOD ZONES WHERE THE FLOOD VELOCITY IS UP TO 5 FT PER SEC.

FOOTING DEPTHS MAY BE DETERMINED BY LOCAL BUILDING OFFICIAL REQUIREMENTS WITH REGARD TO FLOOD VELOCITY AND SOIL TYPE. MINIMUMS OF SHEET 1 MAY NOT APPLY.



**FLOOD MITIGATION DESIGN REQUIREMENTS**

THIS SHEET IS ONLY FOR THE REQUIREMENTS PARTICULAR TO FLOOD MITIGATION SEE SHEET 1 OF 2 FOR OVERALL FOUNDATION INSTALLATION REQUIREMENTS

**ANCHORPANEL® FOUNDATION SYSTEM**

PERMANENT PERIMETER FOUNDATION  
FOR MANUFACTURED HOMES

SHEET 3 OF 3

SHEET 3 NOT REQ'D OUTSIDE OF FLOOD ZONES